

P6701SD Solder Down Serial Analyzer Probe

Installation Manual

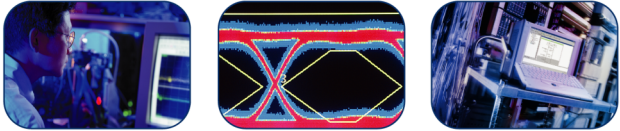

Connecting to the Serial Analyzer Module

Refer to the illustration on the back of these instructions as you perform the following steps:

1. Plug the signal connector into the module and tighten the hold-down screws.
2. Plug the Power Adapter into the module and tighten the hold-down screws.
3. Plug the power connector into the Power Adapter.
4. Refer to the detailed instructions that follow to connect the solder tip to the probe.
5. Refer to the detailed instructions that follow to connect the solder tip to your circuit.

Connecting to the Probe Head

The probe body and tip cable ends are keyed to ensure correct installation. Refer to the illustrations that follow:

1. Orient the probe body with the + and – inputs on top, as shown.
2. Align the tip cable lead with the red band to the + input.

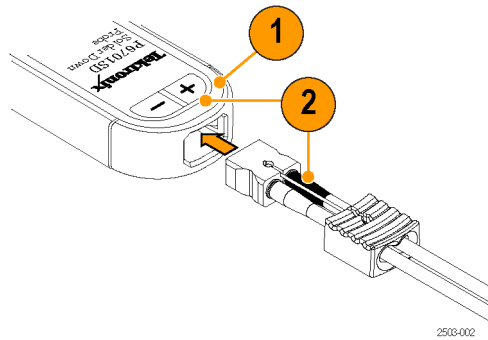

3. Grasp the cable connector by hand and push the cable into the probe body until you feel a click. The cable housing is fully seated when it is flush with the edge of the probe body.
4. To remove the tip, pull the cable tab straight out from the probe body.

CAUTION. You can damage the tip or probe if you pull on the cables. Pull only on the cable tab when removing the tip.

4. Attach tip tape to the bottom of the tip.
5. Clean out the tip vias with a solder-wicking material if you are reusing the tip. Thread the wires through the tip.
6. Press the tip to the circuit board and quickly solder the wires to the tip. Keep all finished wire lengths as short as possible.
7. Clip off the excess wire from all of the solder joints.

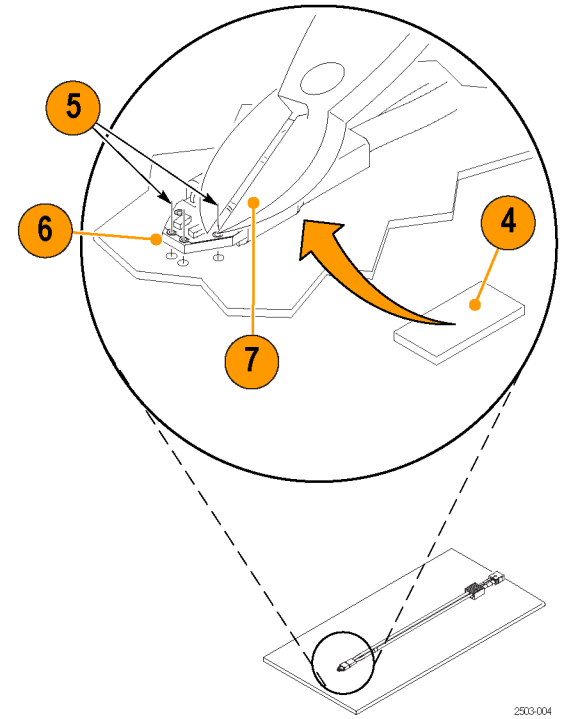

8. Push the end of the tip into the probe head until it seats in the probe head.
9. For a secure mechanical connection, use double-sided tape or hot glue to secure the tip to your circuit.
10. Secure the probe to the circuit board with tape or hook-and-loop strips.



Tektronix

P6701SD Probe

The P6701SD Serial Analyzer Probe is designed to take differential signal measurements from your circuit through a pair of soldered connections. The small footprint of the P75TLRST solder tip lets you acquire signals where mid-bus and interposer serial analyzer probes cannot be used.

The probe documentation that ships with the probe includes this installation guide and an instruction manual in pdf format on the TLA Documentation CD (Tektronix part number 063-3671-08 and above). The installation guide explains the connections that you need to make to begin taking measurements. Standard and optional accessories are listed on the back.

All other information, including specifications, connector pinouts, and channel assignments are covered in the *P67xx Series Serial Analyzer Probes Design Guide & Instruction Manual* on the CD.

Overview

The P6701SD Probe connects to the serial analyzer module through an 8-pin signal connector and a 2-pin power cable. Two of the 8 signal connector pins are used for the + and – signals of the probe as shipped. The signal connector can accommodate up to four probes; see your *P67xx Series Serial Analyzer Probes Design Guide & Instruction Manual* for details on adding probes to the signal connector.

The 2-pin power cable connects to the Power Adapter, which plugs into the module and distributes power for up to eight P6701SD probes.

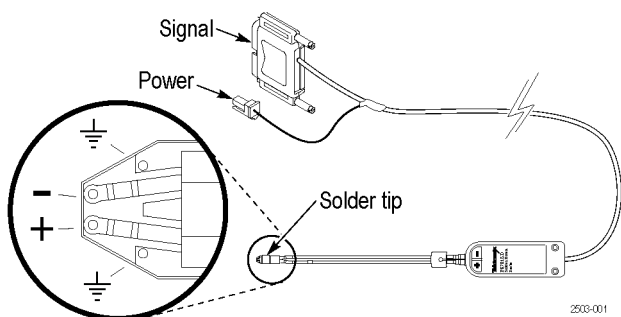

A P75TLRST solder tip is included with the probe and provides a soldered connection on your circuit. It passes the two complementary signals (the + signal and the – signal), and a ground reference to the probe.

Connecting to the Circuit

Use the following steps to solder the tip to your circuit.

NOTE. This tip is very small and must be handled carefully. The following procedures describe the proper techniques for using the tip.

1. Identify a location where the tip can be placed, soldered, and secured to your circuit. You can work with long wires (~1 inch), but keep the finished wire lengths of the signal and ground connections as short as possible.
2. Lay the wires against a circuit board pad, trace, or other conductive feature. (If vias or through-holes are very close, you can thread the wires through them.)
3. Solder the wires to your circuit.

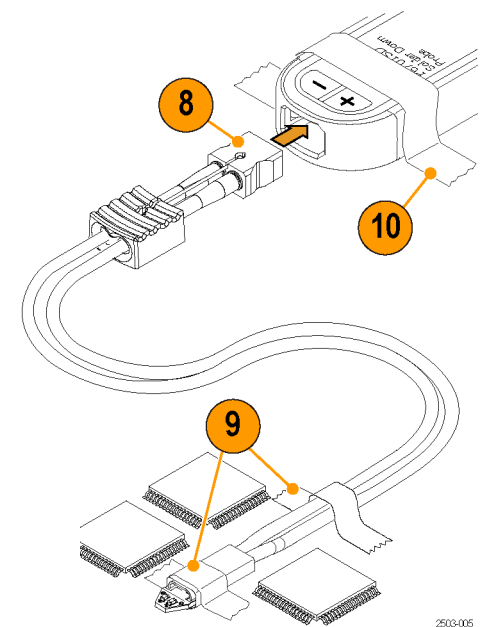
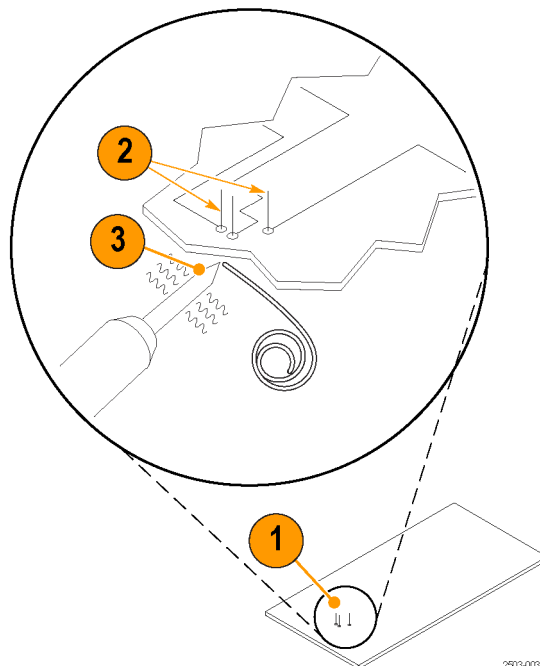

Warranty Information

For warranty information, go to www.tektronix.com/service, and then use the provided links to search for your product's warranty.

Contacting Tektronix

Tektronix, Inc.
14200 SW Karl Braun Drive
PO Box 500
Beaverton, OR 97077 USA

For product information, sales, service, and technical support:

- In North America, call 1-800-833-9200.
- Worldwide, visit www.tektronix.com to find contacts in your area.

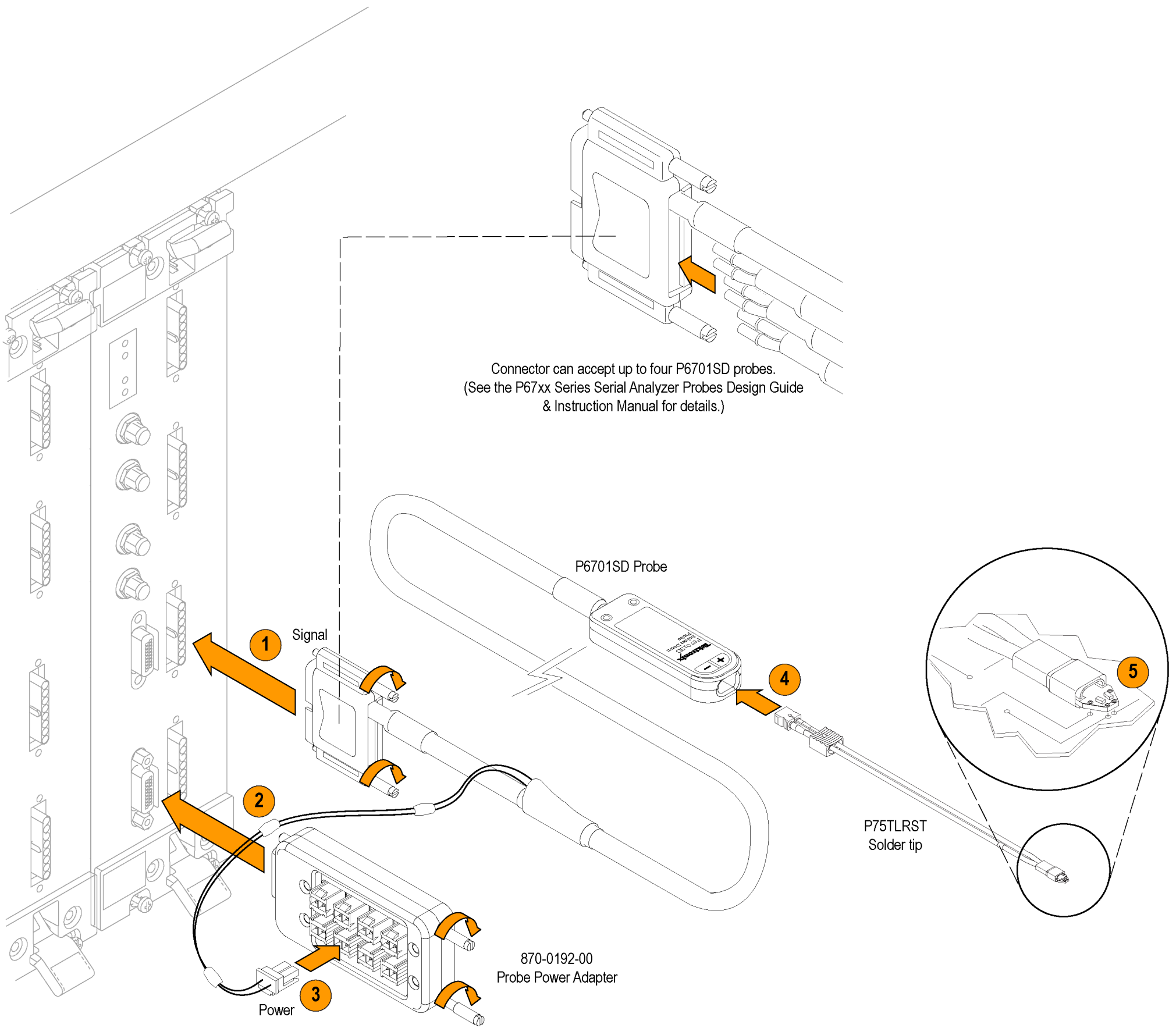

Accessories

Standard

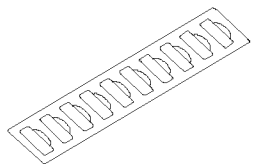
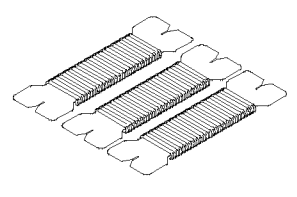
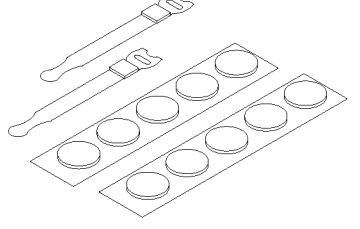
 <p>006-8237-XX (Strip of 10) Solder tip tape</p>	 <p>020-2754-XX (Package of 3 bobbins) 1- .004 wire / 1- .008 wire 1- SAC305 solder</p>	 <p>016-1953-XX Hook and Loop fastening straps and dots</p>
--	---	--

Optional

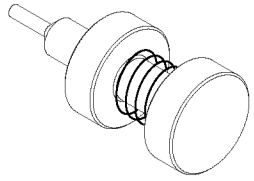
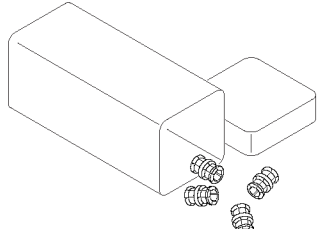
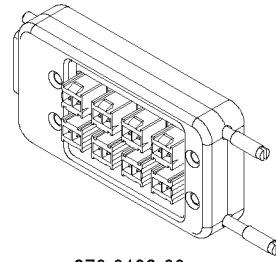
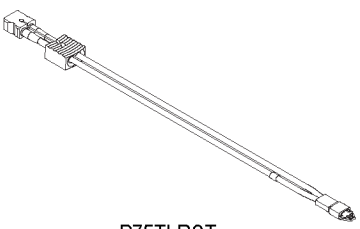
 <p>003-1896-XX Bullet removal tool</p>	 <p>013-0359-XX (Package of 4) Replacement bullet contacts</p>	 <p>870-0192-00 Probe Power Adapter</p>	 <p>P75TLRST Solder tip</p>
--	---	--	--

2503-006